

GLYNN-JOHNSON®

Overhead
door holders/
stops

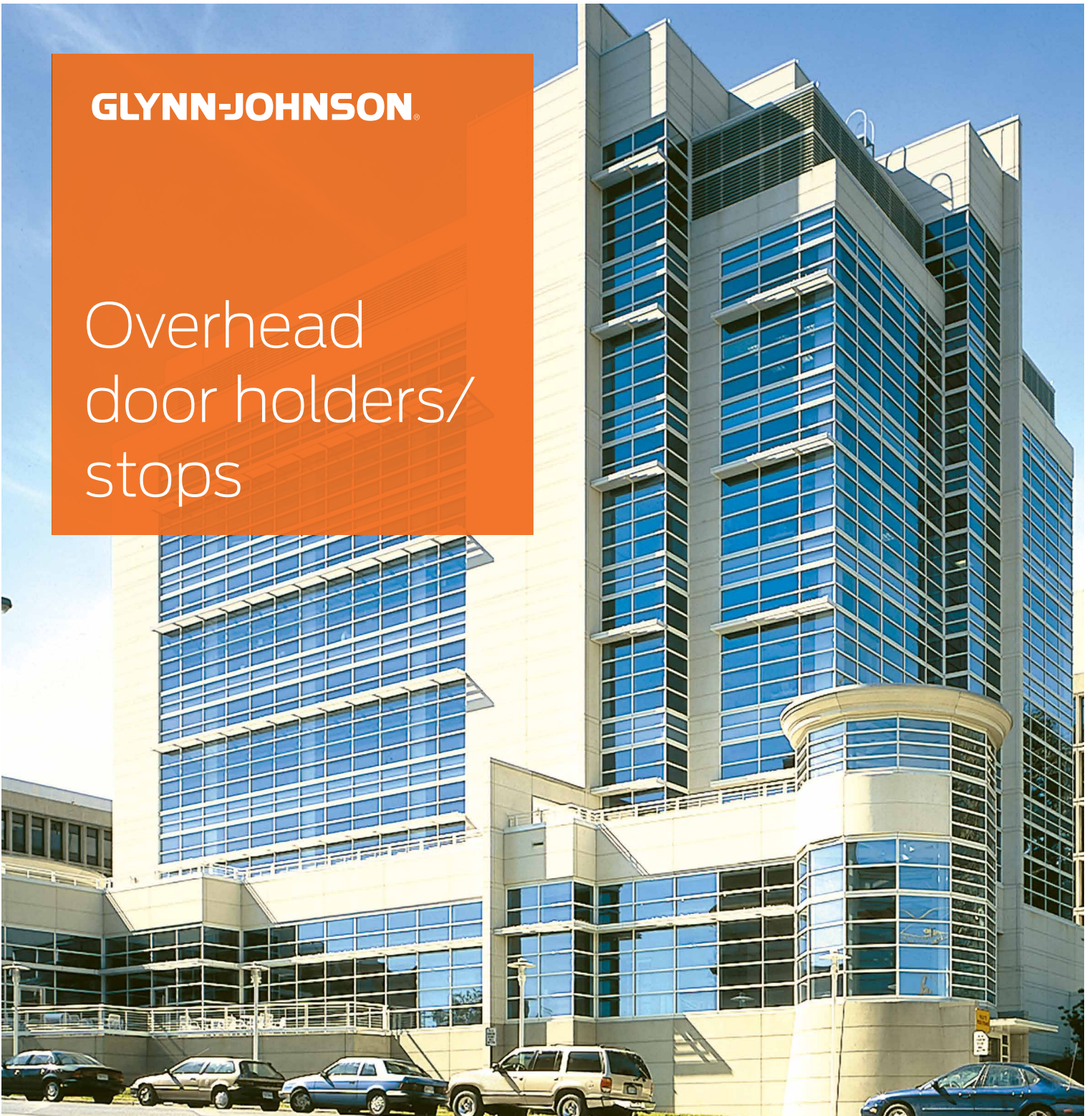



Quality hardware for superior door control

Known throughout the industry as the “overhead door holder specialist,” Glynn-Johnson has made its name with state-of-the-art manufacturing and technology. The portfolio also includes a full line of push/pull latches that are ideal for healthcare applications. Delivering both superior quality and exceptional performance, Glynn-Johnson products are offered in a wide variety of popular finishes and configurations providing the flexibility needed to meet the most demanding door control applications.

Index

General information	4
Installations methods	5
70 & 79 Series	6–9
81 Series	10–13
90 Series	14–17
100 Series	18–21
410 Series	22–25
450 Series	26–29
280 Sensaguard™	30–31

Finishes

Finish no.	Description
US3	Polished brass
US4	Satin brass
US10	Satin bronze
US10B	Oil rubbed bronze
US26	Polished chrome
US26D	Satin chrome
US28	Clear anodized aluminum
US32	Polished stainless steel
US32D	Satin stainless steel
313AN	Dark bronze anodized aluminum
652	Chrome-like coating on steel
SP4	Powder coat brass
SP10	Powder coat bronze
SP28	Powder coat aluminum
SP313	Powder coat dark bronze
SPBLK	Powder coat black

Overhead door holders/stops

Overhead door controls

The best door control device is one that operates overhead, with an arm functioning from the jamb to the top of the door. When the door stopping or hold-open does not exceed 110°, this device is by far the most efficient. The overhead holder and stop is out of the way, in contrast with floor or wall-mounted stops, which can be a stumbling hazard and are vulnerable to damage by accident and vandalism. Glynn-Johnson overhead holders and stops should always be used on doors furnished with door closers, as closers are not door stops and should not be expected to perform that function. Glynn-Johnson overhead stops are designed to protect door closers from violent openings.

Selecting degree of hold-open or stop

Glynn-Johnson overhead holders are designed to function effectively from 85° to 110°. When conditions permit, we recommend the minimum degree of hold-open be set at 95° to put the door knob, pull and panic hardware beyond the flow of traffic. When selecting the degree of hold-open for doors opening back-to-back, or against a wall, please note all Glynn-Johnson overhead holders have shock absorbers which 'give' approximately 5° – 7° beyond the hold-open or initial stop point. The concept of dead stop templating means that the degree of opening be set 5°–7° less than the point of required dead stop to accommodate the compression of the shock absorber.

Door and frame reinforcement

Glynn-Johnson overhead holders and stops are fabricated from top quality brass, steel and stainless steel materials, and are designed to function even under constant heavy-duty abuse. Therefore, it is essential that all doors and frames be adequately reinforced to provide proper anchorage for the overhead stop. For metal doors and frames, we recommend reinforcement be a minimum of $\frac{3}{16}$ " thick, 1 $\frac{1}{2}$ " wide and 12" long to effectively distribute the load. For wood doors and frames, we stress the importance of making them strong enough to provide proper anchorage for the door holders. For reinforcement details, refer to individual templates for each overhead stop.

Definition of "door opening"

Glynn-Johnson defines the terms "door opening" as the actual width of the door opening, from jamb to jamb, not just the width of the door. For example, if you have a 45" opening it would require a size 5 holder if the door is hung on butts or offset pivots. Regardless of the style or series of holders, Glynn-Johnson has standardized the size of holders and stops for all openings, combining the size in the model number. The third digit in all models designates the size. If any further information is required on sizing a holder or stop, contact customer care or your Allegion consultant.

Butts/offset pivots

Concealed series			Surface series					
Size	100	410	Door opening	70	79	81	90	450
1	1012	4112	18" - 23"	-	-	-	-	451
2	1022	4122	23 $\frac{1}{16}$ " - 27"	702	792	-	902	452
3	103	413	27 $\frac{1}{16}$ " - 33"	703	793	813	903	453
4	104	414	33 $\frac{1}{16}$ " - 39"	704	794	814	904	454
5	105	415	39 $\frac{1}{16}$ " - 45"	705	795	815	905	455
6	106	-	45 $\frac{1}{16}$ " - 54"	706	796	816	906	-

¹ Refer to individual catalog pages for further details and for information on center hung applications.

² These sizes not available for use with offset pivots.

³ 796 unit may be templated for use on doors wider than 54". Contact factory with specific information on door frame construction.

Installation methods

Door mounting hardware

Mounting templates for all series holders show various types of hinging methods as well as various degrees of opening. To accommodate the overhead stop to the various mounting methods requires a simple shifting of dimensions A and B. To be assured that reinforcement and mortising are in the proper location, be sure to secure the proper templates from your Glynn-Johnson dealer. These templates include all necessary information for reinforcing door and frame, complete installation instructions for the various mounting methods and the degree of opening required.

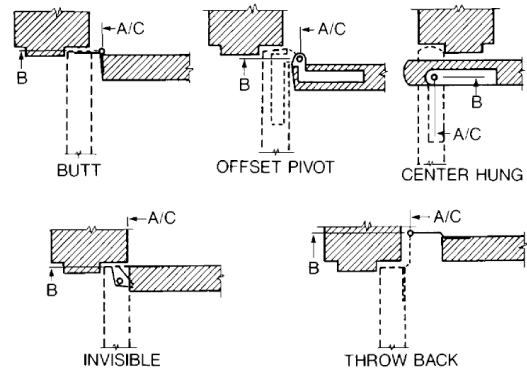

Concealed

Concealed overhead door holder installation requires that the jamb bracket be mortised flush with the bottom of the jamb. The arm and channel must be mortised into the door so the arm is flush with top of the door. A cutout made for the arm on the stop side of single acting doors as in the sketch. Double acting doors require a cutout for the arm on both sides of the door as shown in the sketch. Hollow metal doors must be reinforced at the top of the door to provide necessary strength for the channel. Hollow metal frames must be reinforced in the jamb to provide strength for the jamb bracket. Strength of wood frame and door must be adequate for the holder specified. Accurate template drawings for each holder give complete reinforcement and mortising specifications. They are readily available from your Allegion consultant.

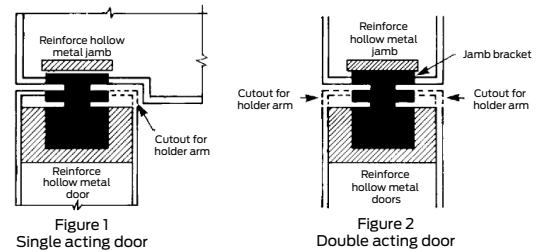

Surface type

Surface mounted overhead door holder installation does not require mortising of jamb or door. The jamb bracket is surface mounted on the stop of the frame. The channel is also surface mounted on the face of the door. Hollow metal doors and jambs must be reinforced to provide necessary strength for the holder specified. Strength of wood doors and jambs must also be adequate for the holder. A typical surface mounted installation is shown in Figure 1 where jamb bracket is fastened to the stop. Angle jamb brackets are available for hinge side mounting (Figure 2) and for use with rabbeted doors or flush transom installations (Figure 3). Jamb brackets with special shims for use on jambs with blade stops are also available (Figure 4). Advise stop height and the appropriate shim kit will be provided.

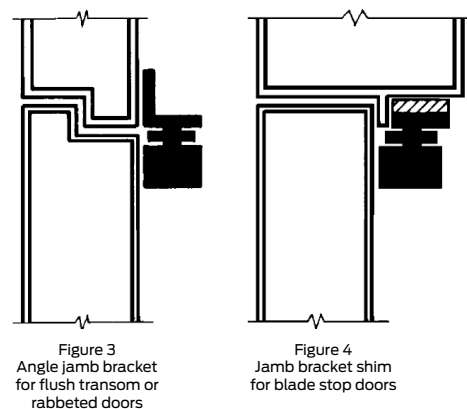
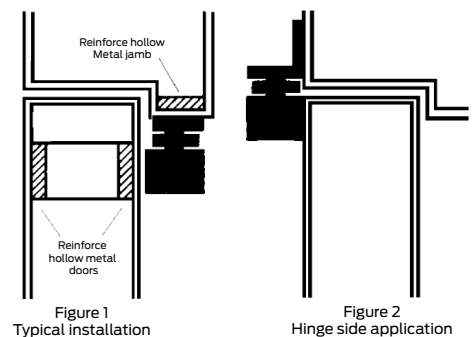

70 & 79 Series surface overhead door holders/stops



70 Series heavy-duty 79 Series extra heavy-duty

Glynn-Johnson offers a complete line of overhead holders and stops, providing solutions for the most complex door control problems. Glynn-Johnson 70 Series and 79 Series surface-mounted holders and stops are designed to meet the demands of high-traffic industrial applications. These units are simple to install.

Compatible with a variety of door closers, these models come with templates to allow for variable mounting positions, ranging from 85° to 110° hold-open/stop angle. These templates are designed for installation in almost all types of doors, including doors with conventional butt-type hinges or specialty hinges.

Four models:

- 70H Series hold-open model – heavy-duty
- 70S Series stop-only model – heavy-duty
- 79H Series hold-open model – extra heavy-duty
- 79S Series stop-only model – extra heavy-duty

Five sizes:

- Simple
- Standardized
- Each model is available in five sizes

Three options:

- J—Angle jamb bracket
- SB—Sex bolt mounting
- SOC—Pin-in-socket security screws

Unmatched convenience:

- Non-handed
- Single-acting doors
- Interior/exterior applications
- Durable
- Easy to install
- Improved corrosion resistance
- Function conversion kits available

Materials and finishes

Glynn-Johnson 70 and 79 Series models are constructed primarily of brass and 300 Series stainless steel substrates, with several components fabricated of steel treated to resist corrosion. Models in the 70 Series utilize a 1/2" diameter stainless steel bar, while the 79 Series uses a 3/4" stainless steel bar.

The bar is always provided in US32D. The spring, washer and nut are provided in a clear zinc finish. The door bracket, jamb bracket and hook (for hold-open units) are available in the following finishes: US3, US4, US10, US10B, US26, US26D, SP4, SP10, SP28, SP313 and SPBLK.

Models

Glynn-Johnson 70 and 79 Series holders and stops offer rugged durability and ease of installation. The surface-applied door and jamb brackets provide reliable door control, yet require minimal door and frame preparation.

Glynn-Johnson 70 Series hold-open and stop-only models provide heavy-duty door protection. The 79 Series models incorporate the basic characteristics of the 70 Series, but can protect extremely heavy or large doors subject to violent use or abusive conditions (i.e., vault doors, cell doors, oversized plant entry doors).

70H and 79H Series hold-open models

(Suffix H) Hold-open models in both series provide a selective hold-open function with easy-to-adjust tension. A simple 90° rotation of the roller mechanism disables the hold-open function, allowing the unit to serve as a shock-absorbing stop. The hold-open function provides a convenient method of holding the door open at a predetermined position for short or long periods of time, permitting an unobstructed traffic flow through the opening.

Both series provide a durable hold-open mechanism that can be turned off, allowing the unit to function as a shock-absorbing stop. The hold-open tension is simply adjusted incrementally for increased or decreased holding power by turning the nut at the end of the bar. While both series are designed for demanding applications, the 79 Series is recommended for extremely heavy or wide doors subject to violent or abusive conditions.

70S and 79S Series stop-only models

(Suffix S) When the hold-open function is not a requirement, stop-only models provide a reliable method of door control. Stop-only models provide the same shock-absorbing capability as hold-open models. The stop-only model may be used on fire doors.

Application information

UL classification

The 70 and 79 Series stop-only models are classified by Underwriters Laboratories (UL) as Miscellaneous fire door accessories. This classification applies to use on either hollow metal fire doors or wood fire doors. These units may be used on doors of any rating. As a reminder, the miscellaneous fire door accessories (GVUX) section is defined by UL as: "Miscellaneous fire door accessories are intended for installation with classified fire doors and/or listed fire door frame as identified in the individual listings. The accessories have been investigated to determine that when installed in accordance with the manufacturer's instructions, the accessories do not adversely affect the fire rating at the fire door and/or fire door frame."

Dead-stop templating

Dead-stop templating is recommended for applications where a wall or similar obstruction is placed at an opening angle of 110° or less (i.e., doors that open back-to-back). Dead-stop templating can be applied to hold-open and stop-only models. The dead-stop position is the point at which the shock-absorbing spring is fully compressed. Therefore, when dead-stop templating is used, the initial degree of opening will be 5° to 7° less than the dead-stop opening.

Example: If the holder is templated to a 100° dead stop, the door will hold open at an angle between 93° and 95° but no further than 100°.

Options

Suffix J (angle jamb bracket)

An angle jamb bracket is available to convert standard models to flush transom mounting. If ordered with unit add suffix J. If needed separately, order either 70J or 79J by finish needed.

Suffix SB (sex bolt mounting)

A package of 4 sex bolts provided with the 79 Series and a package of 2 sex bolts provided with the 70 Series.

Suffix SOC (pin-in-socket security screw)

A screw package with pin-in-socket screw for mounting both the door bracket and jamb bracket is provided instead of the standard screw package.

70 & 79 Series surface overhead door holders/stops

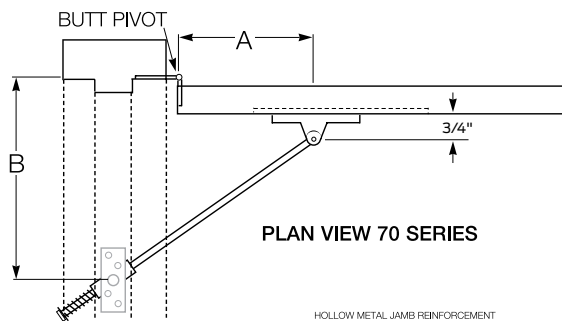

PLAN VIEW 70 SERIES

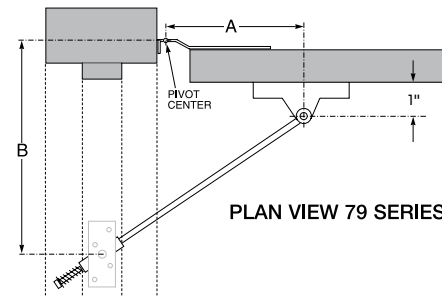

PLAN VIEW 79 SERIES

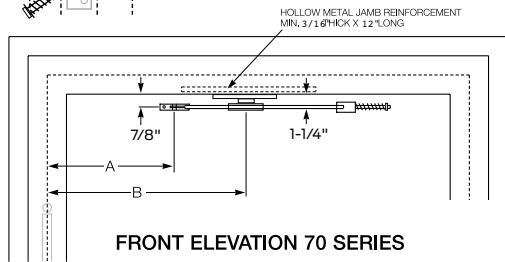

FRONT ELEVATION 70 SERIES

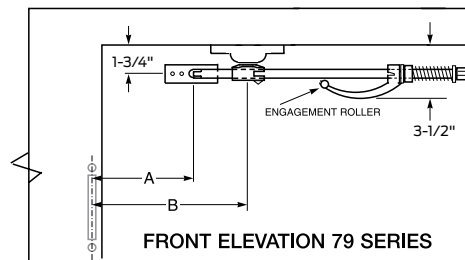

FRONT ELEVATION 79 SERIES

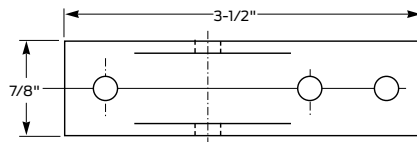

DOOR BRACKET 70 SERIES

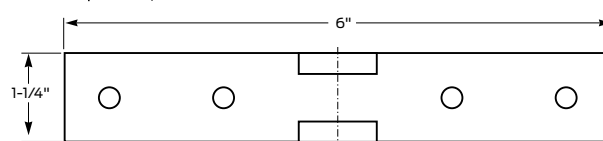

DOOR BRACKET 79 SERIES

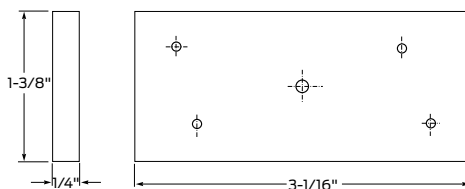

JAMB BRACKET 70 SERIES

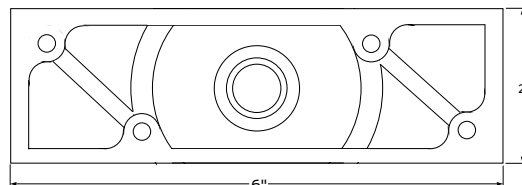

JAMB BRACKET 79 SERIES

70 and 79 Series sizing chart

Size	Butts/offset pivots			Center hung		
	Door opening	Stop only	Hold open	Door opening	Stop only	Hold open
1	-	-	-	-	-	-
2	23 1/16" - 27"	702S/792S	702S/792H	27 1/16" - 33"	702S/792S	702S/792H
3	27 1/16" - 33"	703S/793S	703S/793H	33 1/16" - 39"	703S/793S	703S/793H
4	33 1/16" - 39"	704S/794S	704S/794H	39 1/16" - 45"	704S/794S	704S/794H
5	39 1/16" - 45"	705S/795S	705S/795H	45 1/16" - 51"	705S/795S	705S/795H
6	45 1/16" - 51"	706S/796S	706S/796H	51 1/16" - 59"	706S/796S	706S/796H

Note: This chart illustrates the most common types of hinging and door opening sizes. For unusual door details, contact Glynn-Johnson for availability.

BHMA/ANSI, A156.8 & Fed. spec. cross reference

G-J model	BHMA	Fed. spec.
702H/706H	C08511	G-J 70
702S/706S	C08541	G-J 70
792H/796H	C08511	G-J 70
792S/796H	C08541	G-J 70

The template information on this page is for reference only and is not intended to serve as an installation template. For complete dimensional information, refer to Glynn-Johnson template book.



How to order

	70	4	S	-	US3	-	SB-1
Overhead Series:							
70	Heavy-duty						
79	Extra heavy-duty						
Size (door opening using butts or offset pivots):							
2	(23 1/16"–27")						
3	(27 1/16" –33")						
4	(33 1/16"–39")						
5	(39 1/16"–45")						
6	(45 1/16"–54")						
Function:							
H	Hold-open						
S	Stop-only						
Finishes:							
US3	Polished brass						
US4	Satin brass						
US10	Satin bronze						
US10B	Oil rubbed bronze						
US26	Polished chrome						
US26D	Satin chrome						
SP4	Powder coat brass						
SP10	Powder coat bronze						
SP28	Powder coat aluminum						
SP313	Powder coat dark bronze						
SPBLK	Powder coat black						
Options:							
J	Angle jamb bracket						
SB-1	Sex bolts for door bracket, doors up to 2"						
SB-2	Sex bolts for door bracket, doors from 2" to 3"						
SOC	Pin-in-socket security screws						

81 Series surface overhead door holders/stops



81 Series heavy-duty

Glynn-Johnson offers the most complete line of overhead holders and stops, providing solutions for the most complex door control problems. These surface-mounted holders and stops offer the most effective shock-absorbing capacity, helping protect doors, frames and hardware.

Glynn-Johnson 81 Series holders and stops provide rugged, heavy-duty door control. The jointed-arm design provides the most effective stop mechanism available. The shock absorber bracket is surface mounted, usually with six bolts. The jamb bracket is mounted to the stop of the frame, so a minimum of door and frame preparation is required.

Two models:

- 81H Series hold-open
- 81S Series stop-only

Four sizes:

- Simple
- Standardized
- Each model is available in four sizes

Three options:

- J—Angle jamb bracket
- SHIM—blade stop shims
- SOC—Pin-in-socket security screw package

Unmatched convenience:

- Reversible
- Single-acting doors
- Interior/exterior applications
- Durable
- Easy to install

Materials and finishes

In brass, steel or 300 stainless steel, these models offer the broadest range of finishes in the industry, complementing any design. Stainless steel models offer the highest resistance to corrosion. Available in the following finishes:

Finishes	Description
US3	Polished brass
US4	Satin brass
US10	Satin bronze
US10B	Oil rubbed bronze
US32	Polished stainless steel
US32D	Satin stainless steel
652	Chrome-like coating

Models

Designed for heavy-duty applications, these models provide long-lasting protection for doors, frames, hardware and surrounding walls or obstructions. They are compatible with most door closers and feature an extremely reliable hold-open function and rugged shock absorption. All models feature jointed-arm design and centered jamb bracket.

Designed for heavy-duty applications, 81 Series models are ideal for doors that are opened frequently. They provide long-lasting protection to doors, frames, hinges, related hardware and surrounding walls or obstructions.

81H Series hold-open

(Suffix H) The hold-open model should be used when doors will need to be held open at a preset position for an extended period. This allows unobstructed traffic flow. Hold-open model provides a selective hold-open function. A simple turn of the thumbturn disables the hold-open function, allowing the unit to serve as a shock absorbing stop.

The hold-open mechanism is selective and may be turned on or off with a simple turn of the thumbturn. In the “off” position, these models act as stops and shock absorbers. In the “on” position, they hold the door open at a preset position between 85° and 110°. The hold-open force is not adjustable in the 81H Series.

81S Series stop-only

(Suffix S) When the hold-open function is not required, the stop-only models provide the same effective door control, without the hold-open feature. The stop-only model may be used on fire doors.

Application information

UL classification

The 81 Series stop-only models are classified by Underwriters Laboratories (UL) as miscellaneous fire door accessories. This classification applies to use on either hollow metal fire doors or wood fire doors. These units may be used on doors of any rating. As a reminder, the miscellaneous fire door accessories (GVUX) section is defined by UL as: "Miscellaneous fire door accessories are intended in the individual Listings. The accessories have been investigated to determine that when installed in accordance with the manufacturer's instructions, the accessories do not adversely affect the fire rating of the fire door and/or fire door frames."

Dead-stop templating

If a wall or similar obstruction is in place at an opening angle of 110° or less (i.e. doors that open back-to-back), dead stop templating should be used for all hold-open and stop-only models. The dead stop position is reached when the shock-absorbing spring is fully compressed. The initial degree of opening will be 5° to 7° less than the dead stop opening.

Example: If the holder is templated to 100° dead stop, the door will hold open somewhere between 93° to 95°, but no further than 100°.

Environmental considerations

Environmental factors should always be considered when specifying overhead holders and stops. Doors that are positioned on a building's exterior or subject to corrosive conditions should be equipped with a holder constructed primarily of stainless steel or brass materials. For interior applications, steel is acceptable, though brass substrates generally provide a more attractive architectural-grade finish.

Options

Suffix J (angle jamb bracket)

An option on the 81 Series is the "J" angle jamb bracket, which converts the standard model to flush transom mounting. The angle jamb bracket affixes to the standard jamb bracket. If ordered with unit add suffix J. If need separately order 81J by finish needed.

Suffix SOC (pin-in-socket security screws)

A screw package with pin-in-socket screws for mounting the door bracket and the jamb bracket is provided instead of the standard screw package.

Suffix SHIM (blade stop shims)

Shim kits are available in three sizes:

81 SHIM1 is a 1/4" shim kit

81 SHIM2 is a 1/2" shim kit

81 SHIM3 is a 3/4" shim kit

If ordered with overhead, add suffix SHIM (1, 2 or 3). If needed separately order 81 SHIM 1, 2, or 3 by finish needed.

81 Series surface overhead door holders/stops

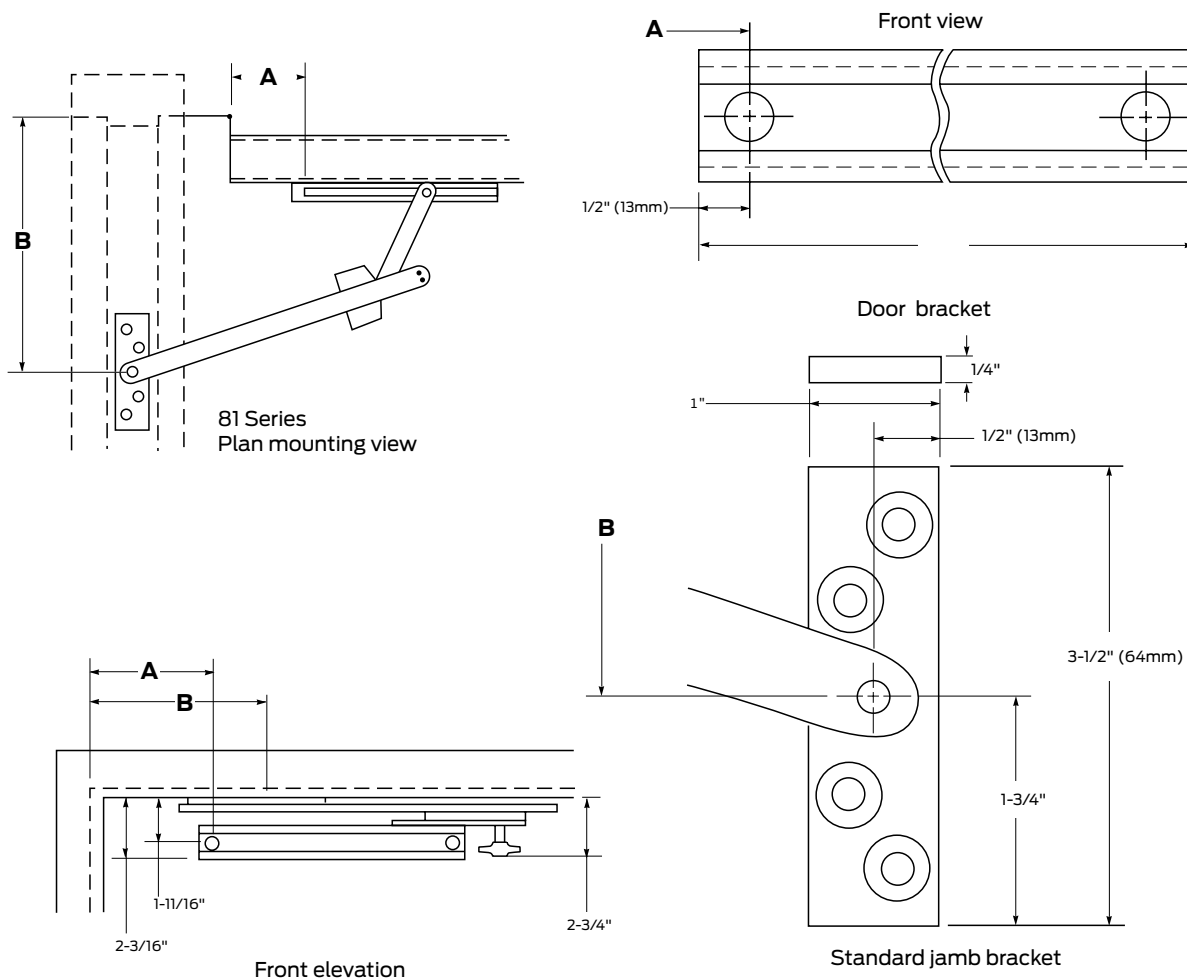

81 Series sizing chart

Butts/offset pivots				Center hung		
Size	Door opening	Stop only	Hold open	Door opening	Stop only	Hold open
1	-	-	-	-	-	-
2	-	-	-	-	-	-
3	27 1/16" - 33"	813S	813H	33 1/16" - 39"	813S	813H
4	33 1/16" - 39"	814S	814H	39 1/16" - 45"	814S	814H
5	39 1/16" - 45"	815S	815H	45 1/16" - 51"	815S	815H
6	45 1/16" - 51"	816S	816H	51 1/16" - 59"	816S	816H

Note: This chart illustrates the most common types of hinging and door opening sizes. For unusual door details, contact Glynn-Johnson for availability.

BHMA/ANSI, A156.8 & Fed. spec. cross reference

G-J model	BHMA*	Fed. spec.
813-816 H	C03511	G-J 80
813-816 S	C03541	G-J 80

* First numeral (0) designates optional material.

To specify:
 Brass material, change 0 to 1 (i.e. C13511)
 Stainless steel material, change 0 to 5 (i.e. C51511)
 Steel material, change 0 to 8 (i.e. C83511)

The template information on this page is for reference only and is not intended to serve as an installation template. For complete dimensional information, refer to Glynn-Johnson template book.



How to order

	81	4	H	– US32D –	SOC
Overhead Series:					
81					
Size (door opening using butts or offset pivots):					
3	(27 1/16" –33")				
4	(33 1/16" –39")				
5	(39 1/16" –45")				
6	(45 1/16" –54")				
Function:					
H	Hold-open				
S	Stop-only				
Finishes:					
US3	Polished brass				
US4	Satin brass				
US10	Satin bronze				
US10B	Oil rubbed bronze				
US32	Polished stainless steel				
US32D	Satin stainless steel				
652	Chrome-like coating				
Options:					
J	Angle jamb bracket				
SHIM	SHIM 1 1/4" kit				
	SHIM 1 1/2" kit				
	SHIM 1 3/4" kit				
SOC	Pin-in-socket security screws				

90 Series surface overhead door holders/stops



90 Series heavy-duty

Glynn-Johnson 90 Series holders and stops are the most rugged models available for heavy-duty applications. The channel is surface-mounted to the door, most often with sex bolts, and the jamb bracket is surface mounted to the jamb, requiring minimal door and frame preparation.

These versatile units can be used in conjunction with most surface-applied door closers. The provided templates allow for variable mounting positions, ranging from 85° to 110° hold-open/stop angle. These templates are designed for installation in almost all types of doors, including doors with conventional butt-type hinges or specialty hinges.

Four models:

- 90H Series hold-open model
- 90S Series stop-only model
- 90F Series friction hold-open model
- 90SE Series special stop-only model

Five sizes:

- Simple
- Standardized
- Each model is available in five sizes

Three options:

- J—Angle jamb bracket
- SHIM—Blade stop shim kits
- SOC—Pin-in-socket security screw package

Unmatched convenience:

- Non-handed
- Improved compatibility with door closers
- Single-acting doors
- Interior/exterior applications
- Durable
- Easy to install
- Improved corrosion resistance
- Function conversion kits available

Materials and finishes

In 300 Series stainless steel, brass and steel substrates, these models are available in the largest selection of finishes in the industry. Stainless steel models offer the highest resistance to corrosion. Available in the following finishes:

Finish	Description
US3	Polished brass
US4	Satin brass
US10	Satin bronze
US10B	Oil rubbed bronze
US32	Polished stainless steel
US32D	Satin stainless steel
SP4	Powder coat brass
SP10	Powder coat bronze
SP28	Powder coat aluminum
SP313	Powder coat dark bronze
SPBLK	Powder coat black
652	Chrome-like coating

Models

Glynn-Johnson 90 Series door holders and stops provide long-lasting protection for doors, frames and hardware. All models incorporate a heavy-duty channel/slide-arm design and offset jamb bracket. This unique design allows for simple field modification of functions, should user requirements change.

90H Series hold-open

(Suffix H) Hold-open models provide a convenient method of holding the door open at a predetermined position for short or long periods of time, permitting an unobstructed traffic flow through the opening. The hold-open function can easily be turned on or off by simply rotating the serrated knob on the bottom of the channel. This knob engages the hold-open mechanism, allowing the door to be held open at a predetermined position ranging from 85° to 110°. When the knob is flipped over, it acts as a stop and shock absorber.

The tension on the hold-open mechanism can be adjusted using a phillips screwdriver to offset air currents or other exterior conditions. The hold-open tension adjustment is located on the top of the slider in the channel.

90S Series stop-only

(Suffix S) When the hold-open function is not a requirement, stop-only models provide a reliable method of door control. Stop-only models provide the same shock-absorbing capability as hold-open models. The stop-only model may be used on fire doors.

90F Series friction hold-open

(Suffix F) Friction hold-open models are ideal for patient room doors, wardrobe and closet doors or similar applications where multiple hold-open positions are desired. The friction tension can be adjusted through the top of the channel using an allen wrench. The friction tension adjustment is located on the top of the slider in the channel.

90SE Series special stop-only

(Suffix SE) When stop-only models are used in conjunction with single-point, hold-only electronic door closers, the stop-only function may be ordered without the shock-absorbing mechanism. Used as an auxiliary stop, these models prolong the life of the closer. The stop location is adjusted using an allen wrench on the stop block located in the channel.

Note: Caution should be taken when using this option in other applications, as the elimination of the shock-absorbing spring can put added stress on the door and frame.

Application Information

UL Classification

The 90 Series stop-only models are classified by Underwriters Laboratories (UL) as miscellaneous fire door accessories. This classification applies to use on either hollow metal fire doors or wood fire doors. These units may be used on doors of any rating. As a reminder, the miscellaneous fire door accessories (GVUX) section is defined by UL as: "Miscellaneous fire door accessories are intended in the individual listings. The accessories have been investigated to determine that when installed in accordance with the manufacturer's instructions, the accessories do not adversely affect the fire rating of the fire door and/or fire door frames."

Dead-stop templating

Dead-stop templating is recommended for applications where a wall or similar obstruction is placed at an opening angle of 110° or less (i.e., doors that open back-to-back). Dead-stop templating can be applied to hold-open, stop-only and friction models. The dead-stop position is the point at which the shock-absorbing spring is fully compressed. Therefore, when dead-stop templating is used, the initial degree of opening will be 5° to 7° less than the dead-stop opening.

Example: If the holder is templated to a 100° dead stop, the door will hold open at an angle between 93° and 95° but no further than 100°.

Note: Do not use dead-stop templating on the 90SE Series since there is no shock-absorbing spring.

Environmental considerations

Environmental factors should always be considered when specifying overhead holders and stops. Doors that are positioned on a building's exterior or subject to corrosive conditions should be equipped with a holder constructed primarily of stainless steel or brass materials. For interior applications, steel is acceptable, though brass substrates generally provide a more attractive architectural-grade finish.

Options

Suffix J (angle jamb bracket)

An angle jamb bracket is available for converting standard models to hinge-side or flush transom mounting. The angle jamb bracket affixes to the standard jamb bracket. If ordered with the unit add suffix J. If needed separately order 90J by finish needed.

Suffix SOC (pin-in-socket security screws)

A screw package with pin-in-socket screws for mounting the door bracket and the jamb bracket is provided instead of the standard screw package.

Suffix SHIM (blade stop shims)

Shim kits are available in 3 sizes
90 SHIM1 is a 1/4" shim kit
90 SHIM2 is a 1/2" shim kit
90 SHIM3 is a 3/4" shim kit

If ordered with overhead, add suffix SHIM (1, 2 or 3). If needed separately order 90 SHIM (1, 2 or 3)–finish.

90 Series surface overhead door holders/stops

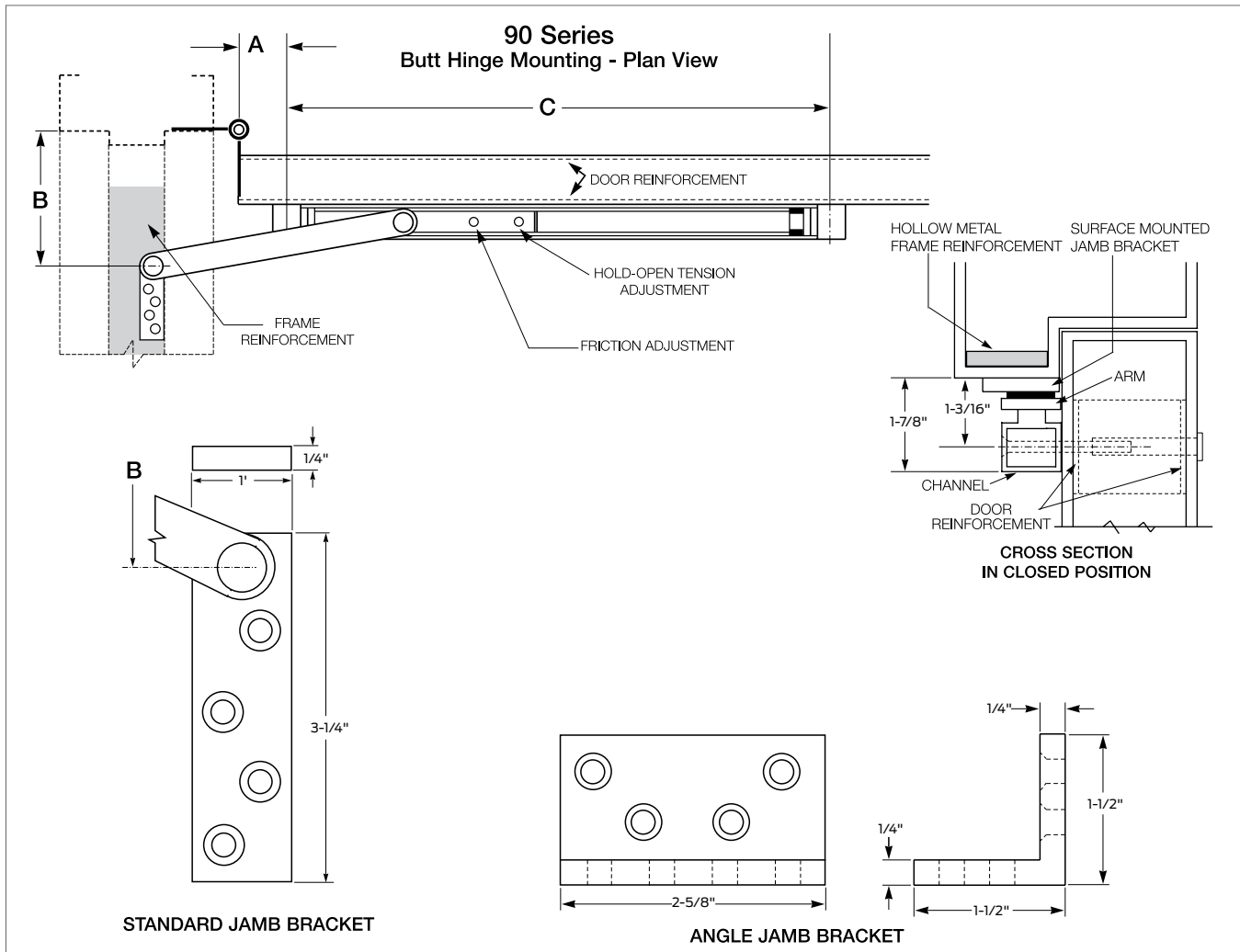

90 Series sizing chart

Butts/offset pivots					Center hung			
Size	Door opening	Stop only	Hold open	Friction	Door opening	Stop only	Hold open	Friction
1	-	-	-	-	-	-	-	-
2	23 1/16" - 27"	902S	902H	902F	27 1/16" - 33"	902S	902H	902F
3	27 1/16" - 33"	903S	903H	903F	33 1/16" - 39"	903S	903H	903F
4	33 1/16" - 39"	904S	904H	904F	39 1/16" - 45"	904S	904H	904F
5	39 1/16" - 45"	905S	905H	905F	45 1/16" - 51"	905S	905H	905F
6	45 1/16" - 51"	906S	906H	906F	51 1/16" - 59"	906S	906H	906F

Note: This chart illustrates the most common types of hinging and door opening sizes. For unusual door details, contact Glynn-Johnson for availability.

BHMA/ANSI, A156.8 & Fed. spec. cross reference

G-J model	BHMA*	Fed. spec.
902-906 H	C02511	1161
902-906 S	C02541	1161A
902-906 F	C02531	-

* First numeral (0) designates optional material.
 To specify:
 Brass material, change 0 to 1 (i.e. C12511)
 Stainless steel material, change 0 to 5 (i.e. C52511)
 Steel material, change 0 to 8 (i.e. C82511)

The template information on this page is for reference only and is not intended to serve as an installation template. For complete dimensional information, refer to Glynn-Johnson template book.



How to order

	90	4	H	-	US32D	-	J
Overhead Series:							
90							
Size (door opening using butts or offset pivots):							
2	(23 1/16"–27")						
3	(27 1/16"–33")						
4	(33 1/16"–39")						
5	(39 1/16"–45")						
6	(45 1/16"–54")						
Function:							
H	Hold-open						
F	Friction hold-open						
S	Stop-only						
SE	Special stop-only						
Finishes:							
US3	Polished brass						
US4	Satin brass						
US10	Satin bronze						
US10B	Oil rubbed bronze						
US32	Polished stainless						
US32D	Satin stainless steel						
SP4	Powder coat brass						
SP10	Powder coat bronze						
SP28	Powder coat aluminum						
SP313	Powder coat dark bronze						
SPBLK	Powder coat black						
652	Chrome-like coating						
Options:							
J	Angle jamb bracket						
SHIM	Blade stop shims						
	SHIM 1 1/4" kit						
	SHIM 2 1/2" kit						
	SHIM 3 3/4" kit						
SOC	Pin-in-socket security screws						

100 Series concealed overhead door holders/stops

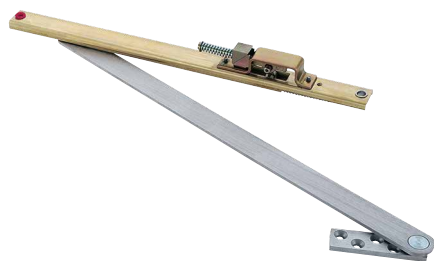

100 Series heavy-duty

Glynn-Johnson offers a complete line of overhead door holders and stops, accommodating virtually all openings with solutions for even the most complex door control problems. These concealed holders and stops provide the most attractive and reliable heavy-duty door control available.

Glynn-Johnson 100 Series holders and stops provide the most reliable and versatile concealed overhead door control. They are designed for installation on virtually all types of doors mounted on conventional type butt hinges, pivots, continuous hinges, swing clear hinges and numerous other specialty hinges. When used in conjunction with many surface-applied door closers, 100 Series holders and stops provide the most effective control for entrance doors and vestibule doors of all types, as well as heavy or often used interior doors. Templates provided allow for variable mounting positions, ranging from 85° - 110° of opening.

Five models:

- 100H Series hold-open model
- 100HP Series internal hold-open model
- 100F Series friction hold-open model
- 100S Series stop-only model
- 100SE Series special stop-only model

Six sizes:

- Each model comes in six sizes.
- Simple
- Standardized

Three options:

- ADJ—Adjustable jamb bracket
- CJ—Jamb Bracket for use with LCN 5030 closer
- SOC—Pin-in-socket security screw package

Unmatched convenience:

- Non-handed
- Improved compatibility with door closers
- Single/double-acting doors
- Interior/exterior applications

- Reduced door prep
- Durable
- Improved corrosion resistance
- Function conversion kits are available

Materials and finishes

In heavy gauge brass or 300 Series stainless steel, these models offer the broadest range of finishes in the industry, complementing any design and offering the highest resistance to corrosion. Available in the following finishes:

Finishes	Description
US3	Polished brass
US4	Satin brass
US10	Satin bronze
US10B	Oil rubbed bronze
US32	Polished stainless steel
US32D	Satin stainless steel
SP4	Powder coat brass
SP10	Powder coat bronze
SP28	Powder coat aluminum
SP313	Powder coat dark bronze
SPBLK	Powder coat black

Models

These models provide a wide range of optional features, and are ideal for use on entrance and vestibule doors, large doors, doors opened frequently, or doors subject to abuse. These models are also furnished with an offset-style jamb bracket.

Designed for heavy-duty applications, 100 Series models will provide long-lasting protection to doors, frames, hinges, related hardware and surrounding walls or obstructions.

100H Series hold-open

(Suffix H) The hold-open function should be used where it is desired to hold a door open at a predetermined position for short or long periods of time, permitting an unobstructed traffic flow through the opening.

These models are both selective and adjustable, featuring the most reliable hold-open mechanism available. They feature a control knob which protrudes from the face of the door and turns the hold-open function on or off. Set in the inactive position, the unit acts as a stop and shock absorber. The tension on the hold-open mechanism can be adjusted using an allen wrench to offset air currents or other exterior conditions. The hold-open tension adjustment is located in the bottom of the track in the top of the door.

100HP Series internal hold-open

These models provide a hold-open unit with the hold-open mechanism built into the channel, thus reducing the door prep. The 100HP have a preset hold-open force that is not adjustable. The hold-open feature is not selectable in these units, so the doors are always held open.

100F Series friction hold-open

(Suffix F) Friction hold-open models provide an alternative holding method, ideal for heavy patient room doors, closet doors or similar applications where multiple hold-open positions are desired. The friction tension is adjusted using an allen wrench and an open end wrench. The friction tension adjustment is located on the top of the slider in the channel.

100S Series stop-only

(Suffix S) When the hold-open function is not required, the stop-only function provides the same effective door control minus the hold-open feature. The stop-only model may be used on fire doors.

100SE Series special stop-only

(Suffix SE) When stop-only models are used in conjunction with single point hold-open electronic door closers, they may be ordered without the shock-absorbing mechanism. Used as an auxiliary stop with these closers, they will prolong the life of the closer. The stop location is adjusted using an allen wrench on the stop block located in the channel.

Note: Caution should be taken when using this option in other applications, as the elimination of the shock-absorbing spring can put added stress on the door and frame.

Application Information

UL Classification

The 100 Series stop-only models are classified by Underwriters Laboratories (UL) as miscellaneous fire door accessories. This classification applies to use on either hollow metal fire doors or wood fire doors. Where wood door manufacturer's listing allows for the cutout required for installation, concealed overhead stops may be used on those wood fire doors. These units may be used on doors of any rating. As a reminder, the miscellaneous fire door accessories (GVUX) section is defined by UL as: "Miscellaneous fire door accessories are intended in the individual listings. The accessories have been investigated to determine that when installed in accordance with the manufacturer's instructions, the accessories do not adversely affect the fire rating of the fire door and/or fire door frames."

Dead stop templating

If a wall or similar obstruction is in place at 110° or less opening angle (i.e. doors that open back-to-back), dead stop templating should be used. This includes all hold-open, friction and stop-only models, except when the "SE" option is used. The dead stop position is reached when the shock-absorbing spring is fully compressed, the initial degree of opening will be 5° to 7° less than the dead stop opening.

Example: If the holder is templated to a 100° dead stop, the door will hold open at an angle between 93° and 95° but no further than 100°.

Note: Do not use dead-stop templating on the 100SE Series since there is no shock-absorbing spring.

Environmental considerations

Environmental factors should always be considered when specifying overhead holders and stops. Doors that are positioned on a building's exterior or subject to corrosive conditions should be equipped with a holder constructed primarily of stainless steel or brass materials. For interior applications, steel is acceptable, though brass substrates generally provide a more attractive architectural-grade finish.

Options

Suffix ADJ (adjustable jamb bracket)

An additional option on the 100 Series is the adjustable jamb bracket, which allows the degree of hold-open or stop angle to be adjusted after installation. Suffix "ADJ" is available in all functions, but only in sizes 3, 4, 5 & 6. ADJ jamb bracket requires additional frame prep. The ADJ option cannot be added to an existing unit, it must be factory ordered.

Suffix CJ (closer jamb bracket)

Provides a special jamb bracket needed for 100 Series units used with LCN 5030 closers. These special jamb brackets are handed, so handing will need to be specified when ordering the "CJ" option, CJLH for a left hand door and CJRH for a right hand door. The CJ option cannot be added to an existing unit, it must be factory ordered.

Suffix SOC (Pin-in-socket security screw package)

A screw package with pin-in-socket screws for mounting the jamb bracket to the frame is provided instead of the standard screw package.

100 Series concealed overhead door holders/stops

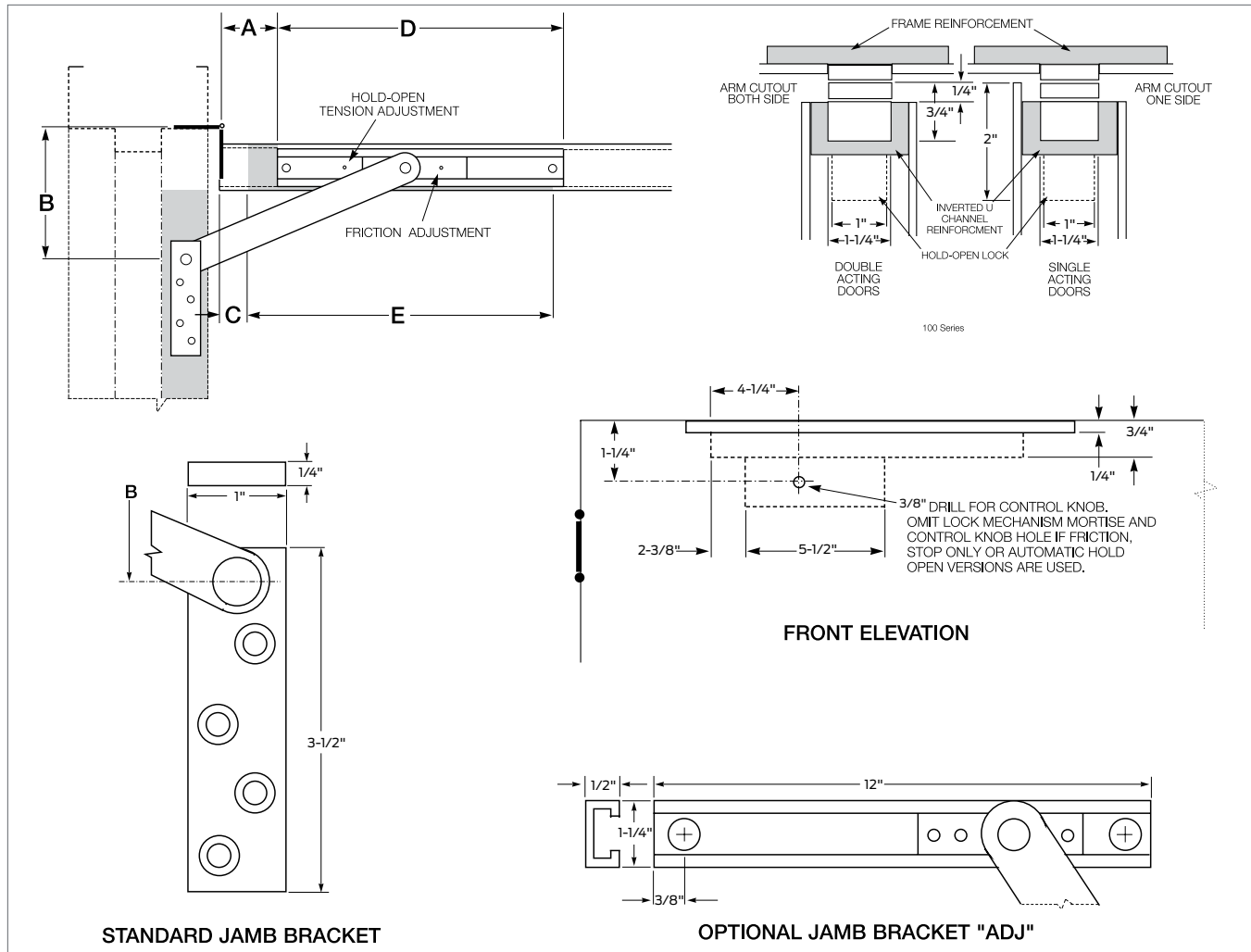

100 Series sizing chart

Butts/offset pivots				Center hung				
Size	Door opening	Stop only	Hold open	Friction	Door opening	Stop only	Hold open	Friction
1	18" - 23"	101S*	101H*	101F*	-	-	-	-
2	23 1/16" - 27"	102S*	102H*	102F*	-	-	-	-
3	27 1/16" - 33"	103S	103H	103F	33 1/16" - 39"	103S	103H	103F
4	33 1/16" - 39"	104S	104H	104F	39 1/16" - 45"	104S	104H	104F
5	39 1/16" - 45"	105S	105H	105F	45 1/16" - 51"	105S	105H	105F
6	45 1/16" - 51"	106S	106H	106F	51 1/16" - 59"	106S	106H	106F

Note: This chart illustrates the most common types of hinging and door opening sizes. For unusual door details, contact Glynn-Johnson for availability.

- * These sizes are not available for use with offset pivots. Also not available with the ADJ option.
- * Wood doors with automatic flush bolts or roller latches, consult factory.

BHMA/ANSI, A156.8 & Fed. spec. cross reference

G-J model	BHMA*	Fed. spec.
101-106 H	C01511	1160
101-106 S	C01541	-
101-106 F	C01531	-

* First numeral (0) designates optional material.

To specify:
Brass material, change 0 to 1 (i.e. C11511)
Stainless steel material, change 0 to 5 (i.e. C51511)

BHMA:
All 100 Series models are designed for heavy-duty applications and far exceed BHMA cycle test and force test requirements for Grade 1 holders and stops.

The template information on this page is for reference only and is not intended to serve as an installation template. For complete dimensional information, refer to Glynn-Johnson template book.



How to order

	10	4	H	-	US26D	-	ADJ
Overhead Series:							
10							
Size (door opening using butts or offset pivots):							
1	(18" - 23")						
2	(23 1/16" - 27")						
3	(27 1/16" - 33")						
4	(33 1/16" - 39")						
5	(39 1/16" - 45")						
6	(45 1/16" - 54")						
Function:							
H	Hold-open						
HP	Internal hold-open						
F	Friction hold-open						
S	Stop-only						
SE	Special stop-only						
Finishes:							
US3	Polished brass						
US4	Satin brass						
US10	Satin bronze						
US10B	Oil rubbed bronze						
US32	Polished stainless						
US32D	Satin stainless steel						
SP4	Powder coat brass						
SP10	Powder coat bronze						
SP28	Powder coat aluminum						
SP313	Powder coat dark bronze						
SPBLK	Powder coat black						
Options:							
ADJ	Adjustable jamb bracket						
CJLH	Special jamb bracket for LCN 5030 closer, LH door						
CJRH	Special jamb bracket for LCN 5030 closer, RH door						
SOC	Pin-in-socket security screws						

410 Series concealed overhead door holders/stops



410 Series medium-duty

Glynn-Johnson offers the most complete line of overhead door holders and stops, offering solutions for the most complex door control problems. The 410 Series offers the industry's widest variety of functions, base materials and finishes to fit all medium to light-duty applications.

The perfect combination of form and function, Glynn-Johnson 410 Series holders and stops offer effective door control and a low-profile design. Each model is constructed so that the channel is encased in the door and the jamb bracket is mortised in the frame. When the door is open, the arm and jamb bracket are visible. Conversely, when the door is in the closed position, the entire holder is completely concealed.

These versatile models can be used with most surface-applied door closers. The provided templates allow for variable mounting positions, ranging from 85° to 110° of opening. These templates are designed for installation in almost all types of doors, including doors with conventional butt-type hinges or specialty hinges.

Four models:

- 410H Series hold-open
- 410S Series stop-only
- 410F Series friction hold-open
- 410SE Series special stop-only

Five sizes:

- Simple
- Standardized
- Each model is available in five sizes

One option:

- Soc—Pin-in-socket security screw package

Unmatched convenience:

- Non-handed
- Improved compatibility with door closers
- Single/double-acting doors

- Interior applications
- Durable
- Easy to install
- Improved corrosion resistance

Materials and finishes

All models are available in 300 Series stainless steel, brass and steel substrates. The broadest range of finishes in the industry is provided to complement any design.

Finishes	Description
US3	Polished brass
US4	Satin brass
US10	Satin bronze
US10B	Oil rubbed bronze
US32	Polished stainless steel
US32D	Satin stainless steel
SP4	Powder coast brass
SP10	Powder coat bronze
SP28	Powder coat aluminum
SP313	Powder coat dark bronze
SPBLK	Powder coat black
652	Chrome-like coating

Models

Glynn-Johnson 410 Series holders and stops are designed for medium- to light-duty applications. They're ideal for openings that are subject to normal activity, providing protection for the door, frame, hinges and surrounding walls or obstructions.

All models incorporate the popular channel/slide-arm design and offset jamb brackets. This improved design allows for simple field modification of functions, should user requirements change.

410H Series hold-open

(Suffix H) Hold-open models provide a convenient method of holding the door open at a predetermined position for short or long periods of time, permitting an unobstructed traffic flow. The hold-open tension can be adjusted using an allen wrench through the end of the slider located in the channel mounted in the top of the door.

These models feature a rugged, automatic hold-open mechanism activated when the door is opened to a preset angle. Each model meets the 250,000 test cycles required for Grade 1 classification. The hold-open feature is not selectable, so the door is always held open.

410S Series stop-only

(Suffix S) When the hold-open function is not a requirement, the stop-only function provides an effective method of door control. The stop-only model may be used on fire doors.

410F Series friction hold-open

(Suffix F) Friction hold-open models are ideal for patient room doors, wardrobe and closet doors, or similar applications where multiple hold-open positions are desired. The friction tension can be adjusted using an allen wrench on the slider located in the channel mounted at the top of the door.

410SE Series special stop-only

(Suffix SE) When stop-only models are used in conjunction with single-point, hold-open electronic door closers, the stop-only function may be ordered less the shock-absorbing mechanism. Used as an auxiliary stop, these optional models prolong the life of the closer. The stop location is adjusted using an allen wrench on the stop block located in the channel.

Note: Caution should be taken when using this option in other applications, as the elimination of the shock-absorbing spring can put added stress on the door and frame.

Application information

UL classification

The 410 Series stop-only models are classified by Underwriters Laboratories (UL) as miscellaneous fire door accessories. This classification applies to use on either hollow metal fire doors or wood fire doors. Where wood door manufacturer's listing allows for the cutout required for installation, concealed overhead stops may be used on those wood fire doors. These units may be used on doors of any rating. As a reminder, the miscellaneous fire door accessories (GVUX) section is defined by UL as: "Miscellaneous fire door accessories are intended in the individual Listings. The accessories have been investigated to determine that when installed in accordance with the manufacturer's instructions, the accessories do not adversely affect the fire rating of the fire door and/or fire door frames."

Dead-stop templating

Dead-stop templating is recommended for applications where a wall or similar obstruction is in place at an opening angle of 110° or less (i.e., doors that open back-to-back). Dead-stop templating can be applied to hold-open, stop-only and friction models. The dead-stop position is

the point at which the shock-absorbing spring is fully compressed. Therefore, when dead-stop templating is used, the initial degree of opening will be 5° to 7° less than the dead-stop opening.

Example: If the holder is templated to a 100° dead stop, the door will hold open at an angle between 93° and 95° but no further than 100°.

Note: Do not use dead-stop templating on the 410SE Series since there is no shock-absorbing spring.

Environmental considerations

Environmental factors should always be considered when specifying overhead holders and stops. Doors that are positioned on a building's exterior or subject to corrosive conditions should be equipped with a holder constructed primarily of stainless steel, brass or bronze materials. For interior applications, steel is acceptable, though brass and bronze substrates generally provide a more attractive architectural-grade finish.

Heavy-use applications

A heavy-duty holder or stop should be considered when doors and frames are subject to heavy, frequent use. Also, heavy-duty units should be considered on exterior doors subject to wind.

Options

Suffix SOC (Pin-in-socket security screw package)

A screw package with pin-in-socket screws for mounting the jamb bracket to the frame is provided instead of the standard screw package.

410 Series concealed overhead door holders/stops

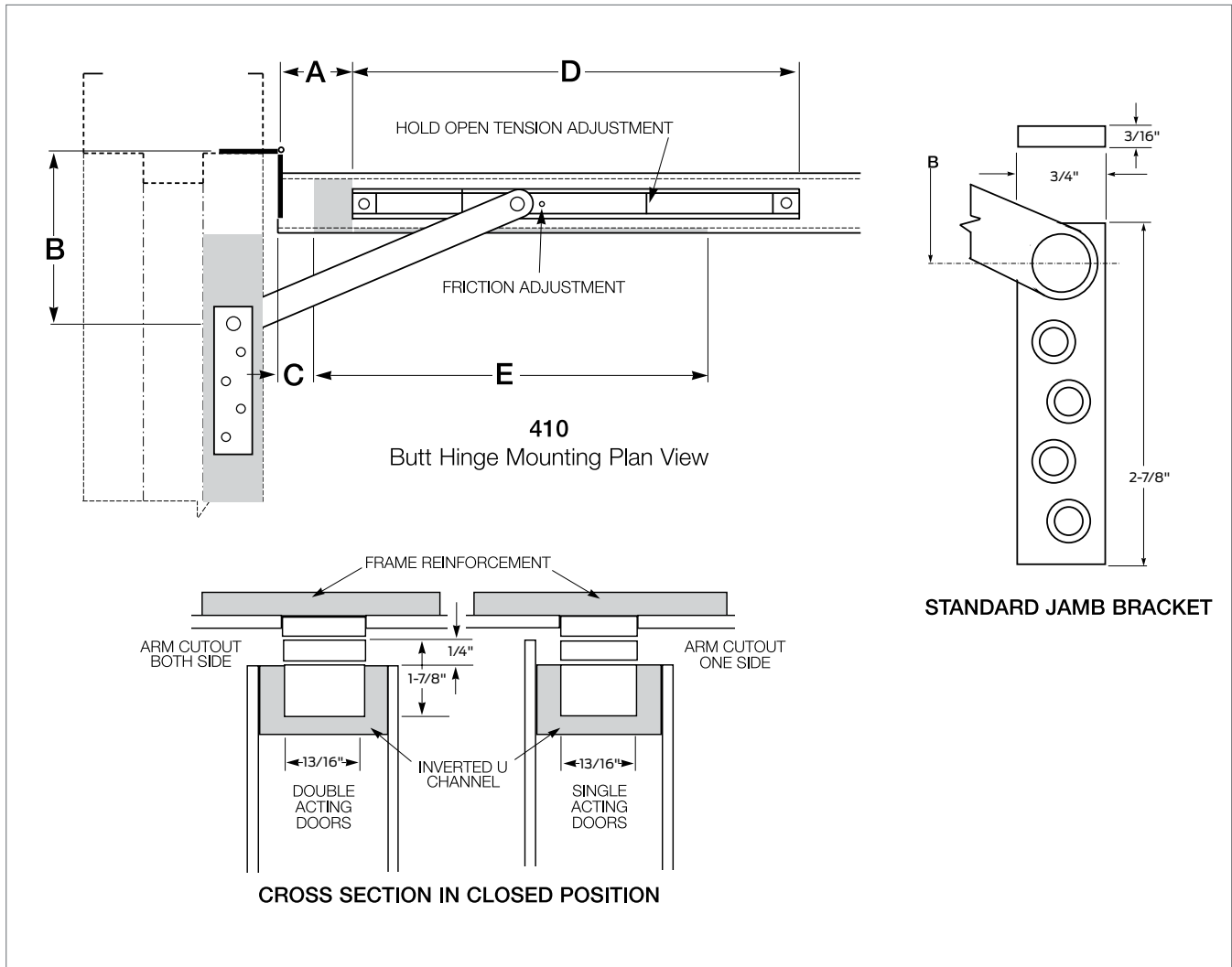

410 Series sizing chart

Butts/offset pivots					Center hung			
Size	Door opening	Stop only	Hold open	Friction	Door opening	Stop only	Hold open	Friction
1	18" - 23"	411S	411H	411F	-	-	-	-
2	23 1/16" - 27"	412S	412H	412F	-	-	-	-
3	27 1/16" - 33"	413S	413H	413F	33 1/16" - 39"	413S	413H	413F
4	33 1/16" - 39"	414S	414H	414F	39 1/16" - 45"	414S	414H	414F
5	39 1/16" - 45"	415S	415H	415F	45 1/16" - 51"	415S	415H	415F

Note: This chart illustrates the most common types of hinging and door opening sizes. For unusual door details, contact Glynn-Johnson for availability.

* Wood doors with automatic flush bolts or roller latches, consult factory.

BHMA/ANSI, A156.8 & Fed. spec. cross reference

G-J model	BHMA*	Fed. spec.
411-106 H	C04511	1166
411-106 S	C04541	1166A
411-106 F	C04531	1164

* First numeral (0) designates optional material.

To specify:
 Brass material, change 0 to 1 (i.e. C14511)
 Stainless steel material, change 0 to 5 (i.e. C54511)
 Steel material, change 0 to 8 (i.e. C84511)

The template information on this page is for reference only and is not intended to serve as an installation template. For complete dimensional information, refer to Glynn-Johnson template book.



How to order

	41	1	H	-	US10B	-	SOC
Overhead Series:							
41							
Size (door opening using butts or offset pivots):							
1	(18" - 23")						
2	(23 1/16" - 27")						
3	(27 1/16" - 33")						
4	(33 1/16" - 39")						
5	(39 1/16" - 45")						
Function:							
H	Hold-open						
F	Friction hold-open						
S	Stop-only						
SE	Special stop-only						
Finishes:							
US3	Polished brass						
US4	Satin brass						
US10	Satin bronze						
US10B	Oil rubbed bronze						
US32	Polished stainless						
US32D	Satin stainless steel						
SP4	Powder coat brass						
SP10	Powder coat bronze						
SP28	Powder coat aluminum						
SP313	Powder coat dark bronze						
SPBLK	Powder coat black						
652	Chrome-like coating						
Options:							
SOC	Pin-in-socket security screws						

450 Series surface overhead door holders/stops



450 Series medium-duty

Glynn-Johnson provides the most complete line of overhead holders and stops, offering solutions for the most demanding door control problems. These surface-mounted holders and stops offer the widest variety of functions, materials and finishes to fit all medium- to light-duty applications.

Glynn-Johnson 450 Series holders and stops provide reliable and versatile surface-mounted overhead door control for all medium to light-duty applications. The visible components are available in a wide variety of architectural finishes to complement any design.

The 450 Series holders and stops are designed for installation in virtually all types of doors and frames including doors with conventional butt hinges, offset pivots, continuous hinges, swing clear hinges and many other specialty hinges. The templates provided allow for variable mounting positions, ranging from 85° - 110° of opening.

Four models:

- 450H Series hold-open model
- 450S Series stop-only model
- 450F Series friction hold-open model
- 450SE Series special stop-only model

Five sizes:

- Simple
- Standardized
- Each model is available in five sizes

Three options:

- J—Angle jamb bracket
- SHIM—Blade stop SHIM kit
- Soc—Pin-in-socket security screw package

Unmatched convenience:

- Non-handed
- Improved compatibility with door closers
- Improved jamb bracket design

- Single acting doors
- Interior applications
- Durable
- Easy to install
- Improved corrosion resistance

Materials and finishes

In brass, 300 Series stainless steel or steel, these models offer the broadest range of finishes in the industry to complement any design. Brass and stainless steel offer the highest resistance to corrosion, while all these base materials are suitable for normal interior use.

Finish	Description
US3	Polished brass
US4	Satin brass
US10	Satin bronze
US10B	Oil rubbed bronze
US32	Polished stainless steel
US32D	Satin stainless steel
SP4	Powder coat brass
SP10	Powder coat bronze
SP28	Powder coat aluminum
SP313	Powder coat dark bronze
SPBLK	Powder coat black
652	Chrome-like coating

Models

Glynn-Johnson 450 Series holders and stops are designed for medium to light-duty applications. They're ideal for openings that are subject to normal activity, providing protection for the door, frame, hinges and surrounding walls or obstructions.

Designed for improved compatibility with most door closers, all models incorporate popular channel/slide arm design and offset jamb brackets. The improved design makes it easier to change functions in the field, should user requirements change.

450H Series hold-open

(Suffix H) These models conveniently hold doors open at a predetermined position, permitting unobstructed traffic flow.

These models feature an adjustable automatic hold-open that is activated when the door is opened to a preset angle. The hold-open tension can be adjusted using an allen wrench through the end of the slider located in the channel at the top of the door. Each meets the 250,000 test cycles required for Grade 1 classification.

450S Series stop-only

(Suffix S) When the hold-open function is not required, the stop-only function provides the same effective door control without keeping the door held open. The stop-only model may be used on fire doors.

450F Series friction hold-open

(Suffix F) Friction hold-open models provide an alternative holding method ideal for patient room doors, wardrobe or closet doors, or similar applications where multiple hold-open positions are desired. The friction tension can be adjusted using an allen wrench on the slider located in the channel at the top of the door.

450SE Series special stop-only

(Suffix SE) When stop-only models are used in conjunction with single point hold-open electronic door closers, the function may be ordered without the shock absorbing mechanism. Used as an auxiliary stop with these closers, they will prolong the life of the closer. The stop location is adjusted using an allen wrench on the stop block located in the channel.

Note: Caution should be taken when using this option in other applications, as the elimination of the shock-absorbing spring can put added stress on the door and frame.

Application information

Closer applications

Glynn-Johnson 450 Series models require minimal door and frame preparation. They may be used in conjunction with most surface-applied door closers. In some cases, optional drop brackets may need to be mounted on the closers. These brackets are available from the closer manufacturer.

UL classification

The 450 Series stop-only models are classified by Underwriters Laboratories (UL) as miscellaneous fire door accessories. This classification applies to use on either hollow metal fire doors or wood fire doors. These units may be used on doors of any rating. As a reminder, the miscellaneous fire door accessories (GVUX) section is defined by UL as: "Miscellaneous fire door accessories are intended in the individual listings. The accessories have been investigated to determine that when installed in accordance with the manufacturer's instructions, the accessories do not adversely affect the fire rating of the fire door and/or fire door frames."

Dead-stop templating

For situations where a wall or similar obstruction is in place at an opening angle of 110° or less (e.g. doors that open back-to-back), dead stop templating should

be used. This includes all hold-open, Friction and stop-only models, except when the "SE" option is used.

The dead stop position is reached when the shock-absorbing spring is fully compressed, allowing an initial degree of opening of 5° to 7° less than the dead stop opening.

Example: If the holder is templated to a 100° dead stop, the door will hold open at an angle between 93° and 95° but no further than 100°.

Note: Do not use dead-stop templating on the 450SE Series since there is no shock-absorbing spring.

Environmental conditions

To assure a long operating life for holders and stops, consider the environment where they will be used. Doors that open to the exterior of a building or are subject to corrosive conditions should have a holder constructed primarily of stainless steel, brass or bronze materials. For interior doors, steel material may be acceptable, although brass and bronze substrates will provide a more attractive architectural grade finish.

Heavy-use applications

Where doors and frames are subject to heavy use and abuse, a heavy-duty holder or stop should be considered. Also heavy-duty units should be considered on exterior doors subject to wind.

Options

Suffix J (angle jamb bracket)

An additional option on the 450 Series is the angle jamb bracket for hinge-side or flush transom mounting. The angle jamb bracket affixes to the standard jamb bracket. If ordered with the overhead add suffix J. If needed separately order 450J-finish.

Suffix SHIM (blade stop shims)

Shim kits are available in 3 sizes:

450 SHIM1 is a 3/16" shim kit

450 SHIM2 is a 3/8" shim kit

450 SHIM3 is a 9/16" shim kit

If ordered with overhead, add suffix SHIM (1, 2 or 3).

If needed separately order 450SHIM (1, 2 or 3)–finish.

Suffix SOC (Pin-in-socket security screw package)

A screw package with pin-in-socket screws for mounting the channel to the door and the jamb bracket to the frame is provided instead of the standard screw package.

450 Series surface overhead door holders/stops

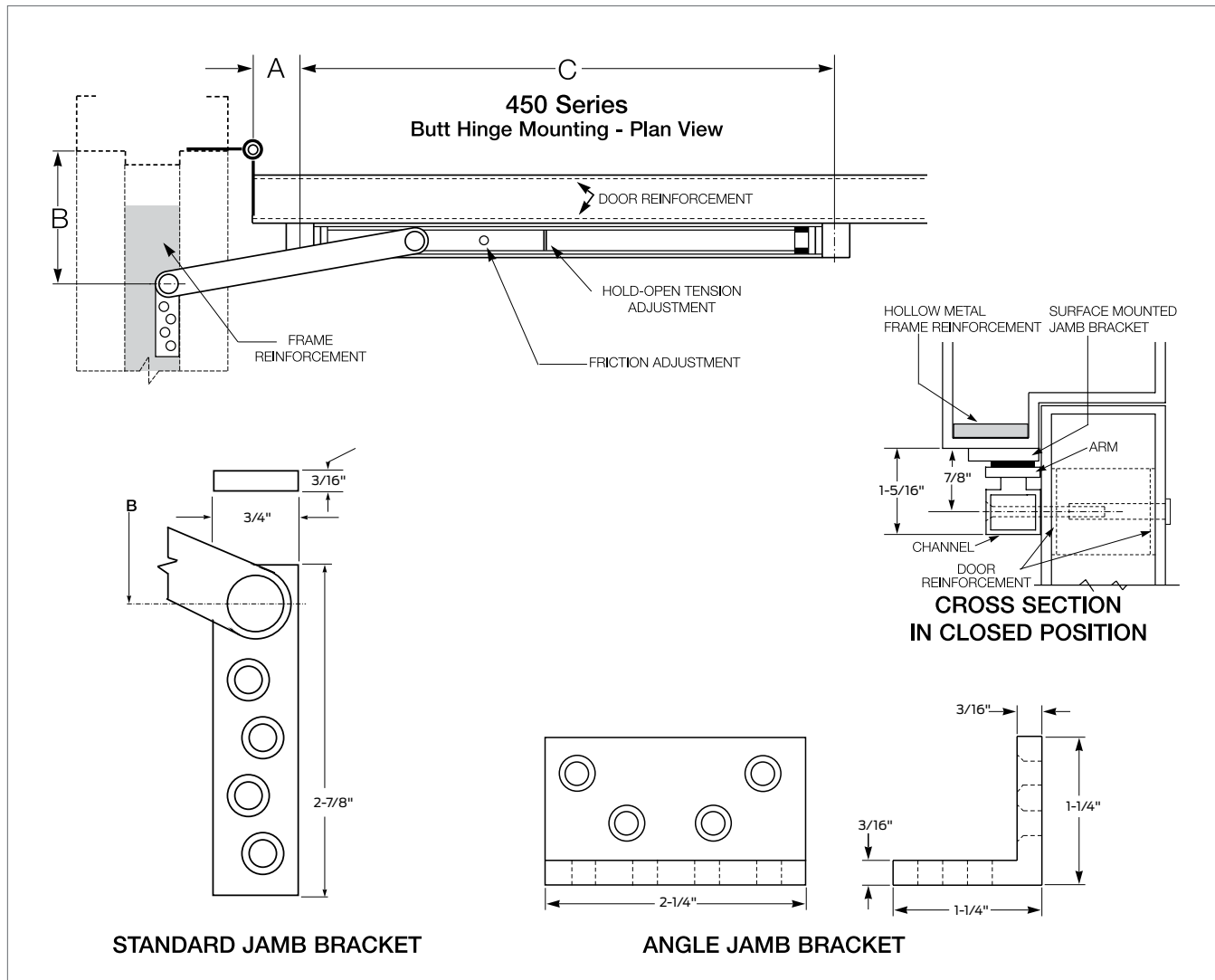

450 Series sizing chart

Butts/offset pivots					Center hung			
Size	Door opening	Stop only	Hold open	Friction	Door opening	Stop only	Hold open	Friction
1	18" - 23"	451S	451H	451F	23 1/16" - 27"	451S	451H	451F
2	23 1/16" - 27"	452S	452H	452F	27 1/16" - 33"	452S	452H	452F
3	27 1/16" - 33"	453S	453H	453F	33 1/16" - 39"	413S	413H	413F
4	33 1/16" - 39"	454S	454H	454F	39 1/16" - 45"	414S	414H	414F
5	39 1/16" - 45"	455S	455H	455F	45 1/16" - 51"	415S	415H	415F

Note: This chart illustrates the most common types of hinging and door opening sizes. For unusual door details, contact Glynn-Johnson for availability.

BHMA/ANSI, A156.8 & Fed. spec. cross reference

G-J model	BHMA*	Fed. spec.
451-455 H	C05511	1166
451-455 S	C05541	1166A
451-455 F	C05531	1164

* First numeral (0) designates optional material.
 To specify:
 Brass/bronze material, change 0 to 1 (i.e. C15511)
 Stainless steel material, change 0 to 5 (i.e. C55511)
 Steel material, change 0 to 8 (i.e. C85511)

The template information on this page is for reference only and is not intended to serve as an installation template. For complete dimensional information, refer to Glynn-Johnson template book.



How to order

	45	1	H	-	US32D	-	J
Overhead Series:							
45							
Size (door opening using butts or offset pivots):							
1	(18" - 23")						
2	(23 1/16" - 27")						
3	(27 1/16" - 33")						
4	(33 1/16" - 39")						
5	(39 1/16" - 45")						
Function:							
H	Hold-open						
F	Friction hold-open						
S	Stop-only						
SE	Special stop-only						
Finishes:							
US3	Polished brass						
US4	Satin brass						
US10	Satin bronze						
US10B	Oil rubbed bronze						
US32	Polished stainless						
US32D	Satin stainless steel						
SP4	Powder coat brass						
SP10	Powder coat bronze						
SP28	Powder coat aluminum						
SP313	Powder coat dark bronze						
SPBLK	Powder coat black						
652	Chrome-like coating						
Options:							
J	Angle jamb bracket						
SHIM	Blade stop shims						
	SHIM 1 3/16" kit						
	SHIM 2 3/8" kit						
	SHIM 3 9/16" kit						
SOC	Pin-in-socket security screws						

Holder/release smoke detector



Series 280 SENSAGUARD™

Glynn-Johnson provides a holder/release smoke detector designed to allow fire doors to remain open for easy passage, while releasing doors in an emergency. The SensaGuard™ Series 280 features an internal ionization-type smoke detector, powered by a single nine-volt battery. Its fail-safe operation automatically releases the door when battery power drops below 7.2 volts.

Safe and dependable

- Fail safe operation
- Battery operated
- Automatic release when battery power drops

Unmatched convenience

- Easy to install
- Self-contained
- Adjustable hold-open
- Stand-alone detector/holder

UL listed

- Fail safe electronics

Ideal for a variety of uses, including:

- Office building corridors
- Factories
- Schools
- Hospitals
- Nursing home patient rooms
- Multifamily residential units

Adjustable hold-open

- SENSAGUARD™ will hold the door open at a single, adjustable position:
 - Pull side mounted adjustable from 90° to 130°
 - Push side mounted adjustable from 90° to 180°
- Adjustable hold-open force

NFPA 101, life safety code

- 5–2.1.8 Self closing devices exception C, 2

Finishes

- US28 Clear anodized aluminum
- 313AN Dark bronze anodized aluminum

Dimensions

- Channel 27" long x 1 3/8" tall x 2 1/8" depth
- Angle bracket 2 3/4" wide x 1" Tall x 1 1/2" depth

Battery requirement

- Unit is furnished with battery.
- To replace battery, use a 9V Alkaline Eveready Energizer® #522 battery or Duracell® #MN1604. Do not substitute.

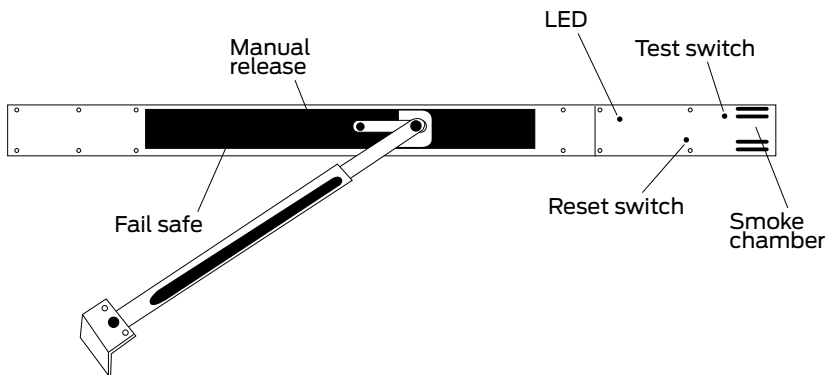

Test switch

Allows testing for proper operation of the release mechanism.

Reset switch

Used to reset the unit after testing or smoke detection.

Smoke chamber

An ionization chamber that when smoke or particles of combustion are detected will release the door.

LED indicator

Monitors the battery condition and signals status every 40 seconds.

Fail safe operation

Releases the hold-open when battery is below 7.2 volts or if battery or battery cover is removed.

Manual release

Allows the door to close when pulled to the closed position. The unit will reset when the door is returned to hold-open position.

Easy to install

SENSAGUARD™ holder/release is easy to install. The unit surface mounts to the top of the door frame and the arm attaches to the door. The unit is battery operated, self-contained and requires no external wiring.

